



Owner's Manual

Professional Amplifier



DA SERIES

This manual does not contain all the information about the design, production, and changes of the equipment, and does not cover all the conditions that may occur during the installation, use and maintenance.

The information provided in this manual is accurate at the time of delivery of the equipment, it maybe has been changed because of the product upgrade.

IMPORTANT SAFETY INSTRUCTIONS

- 1、 The equipment can only be inserted in the power outlet that is indicated by the manual. Otherwise it may cause fire or electric shock.
- 2、 Do not place the container with liquid or small metal objects on the equipment. Otherwise, the liquid or metal falling into the equipment may cause fire or electric shock.
- 3、 Do not place the weight (including the equipment) on the power cord. Otherwise, it may damage the power cord, which can lead to fire or electric shock.
- 4、 Do not place the power cord in the vicinity of the heater. Otherwise it may lead to melting, causing a fire.
- 5、 Do not scratch, bend, twist, stretch or heat power cord. Otherwise, it may damage the power cord, which can lead to fire or electric shock.
- 6、 Pull off the power plug from the power outlet, please grasp the insulation part of the plug, do not pull the cable. Otherwise, it may damage the power cord and the socket, which can lead to fire or electric shock.
- 7、 Do not use wet hands to touch the power plug. Otherwise it may cause electric shock.
- 8、 Please do not let water enter the equipment or make it affected with damp. Otherwise it may cause fire or electric shock.
- 9、 Please do not use the equipment in the following occasions:
 - _An unstable platform surface, such as a shaking table or an inclined plane.
 - _A place where the air is exposed to high humidity or where dust accumulates.
 - _Exposed to an overheated environment, such as a window in a closed car or in direct sunlight.
 - _Exposed to splash oil foam, such as steam, stoves, boilers, humidifiers and other places.
- 10、 There are ventilation holes in front and behind the equipment, to avoid the impact of internal cooling, do not block the ventilation holes.
- 11、 Please keep enough space around the equipment. Reserved space should not be less than: side 5cm, behind 10cm, and air flow unblocked.
- 12、 If you want to move the equipment, please unplug the power plug and unplug all the connecting cables. Otherwise, it may damage the cable, which can lead to fire or electric shock.
- 13、 Attachment of the equipment (such as machine foot, manual bag, desiccant, etc.) please put them in the place where children can not get them.
- 14、 Do not open the equipment cover. Otherwise may lead to electric shock. If you think the equipment needs to be repaired or maintained, please contact the agent.
- 15、 Do not unauthorized change the equipment. Otherwise, it may result in abnormal, fire or electric shock.
- 16、 If lightning strikes, please close the power switch as soon as possible, and unplug the power cord.
- 17、 The equipment output signal may be high voltage, there is a risk of electric shock, please use a dedicated connection header.
- 18、 Connect the speakers to the amplifier output socket, can only use special speaker cable. Use of other cables may cause fire.
- 19、 When connecting to the equipment, please turn off all the audio equipments and speakers.
- 20、 Before turning on the equipment, be sure to turn the volume knob to the minimum. Otherwise, a sudden burst of sound may damage your hearing.
- 21、 If you will not use the equipment for a long time, please unplug the power cord from the AC power outlet. Otherwise it could cause a fire.
- 22、 If the power cord is damaged (such as cut off or bare wire), get the replacement from the agent. Or continue to use the equipment may cause fire or electric shock.
- 23、 If the equipment is shell damage or falling from high, please immediately turn off the power switch, and unplug the power cord, and contact the agent. Otherwise it may cause fire or electric shock.
- 24、 When any abnormal, such as smoke, odor, etc., please immediately turn off the power switch, unplug the power cord, and contact the agent. Otherwise, it may lead to fire or electric shock.

1 Preface

Thank you for your trust, buy our class D power amplifier!

Our company focus on class D power amplifier. The a high level of R&D team, experienced production team and high-quality technical support team ensure that our products used in a variety of environment are stable and reliable, and bring you a pleasant experience.

In order to maximize the efficiency of the equipment, bring you a pleasant experience, please read this manual carefully.

1.1 Performance overview



- a、 High efficiency and energy saving, operation cost is low.
- b、 Compact and light weight , structure is firm.
- c、 Comply with the safety and EMC standards.
- d、 90~260VAC / 50~60HZ Wide range power supply.
- e、 First-class quality, thanks for the components from international high-end manufacturers.
- f、 Temperature control fan for quiet operation.
- g、 Modular design and maintenance is convenient.
- h、 Very suitable for mobile show.
- i、 Reasonable design makes you feel relaxed in the process of using.

1.2 How to use this manual

This manual provides the basic information for the proper installation and use of the equipment, and does not cover all the conditions that may arise in the actual project. For more information, please visit our website or contact our technical support, system installation personnel or agents.

Please take care of the sales order or invoice for your purchase of this equipment. You need to show the credentials when the product is guaranteed.

1.3 Warning sign

	<p>Important operation or special note</p>
	<p>Risk of electrical shock</p>

1.4 Maintenance information card

This manual attached with "maintenance information card", if the equipment sends back to the agent or service center to repair, please fill in the form and transported together with the equipment.

2 Environmental protection, energy saving, cost saving

Thank for the high efficiency class D power amplifier and switching power supply technology, the energy efficiency ratio of the equipment is more than 80% in routine use, more than 90% in laboratory.

Thank for the active power factor correction technique, the equipment can be used allover the world, and minimizing the interference to the power grid, improve energy utilization efficiency.

Advantages of high efficiency:

- * Low working temperature, reliability will be improved obviously.
- * The size and weight are only 1/3 of tradition amplifier.
- * The cost for transportation, handling, installation will reduce obviously.

- * Saving energy, reducing operating costs
- * Environmental protection

Aluminum, copper and steel are greatly reduced, saving energy and resources; reduce transportation emissions 70%.

Climate warming is a challenge to the world, energy saving and emission reduction are effective measures to solve the climate.

We are committed to providing environmental friendly products. For blue sky , white clouds, green mountains and rivers ,let us act together!

3 Installation

3.1 check out of the box

Open packaging and check whether the equipment is damaged in the transportation .

If the equipment is damaged, please inform the shipping company immediately, only you have the right to request compensation for shipping damage. Please save the packing case as evidence of damage for the shipping inspection. We will provide the necessary assistance for you.

It is recommended that you save all packaging materials for use in the transportation equipment. Do not transport the equipment in the absence of an outer package, so as not to damage the equipment.



Packing list:

amplifier	one pcs	User's manual	one pcs
Power cord	one pcs	Speakon connection head	one pcs
Machine foot	four pcs		

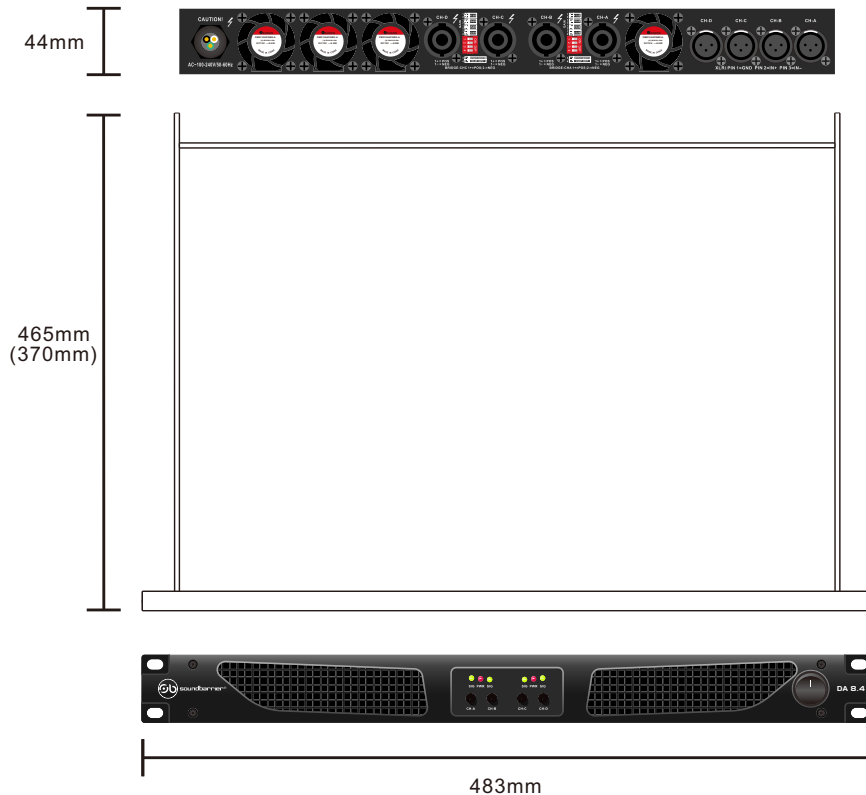
3.2 Outline dimensions



3.3 Installation preparation

	<p>Warning: before installation, please confirm that you see and read the safety warning.</p>
	<p>Before installation, make sure that the power cord is not connected to the power outlet; The power switch is turn off; The volume knob is completely closed (counter clockwise to the limit).</p>
	<p>The equipment is high power, around a strong magnetic field. Keep the signal sensitive equipment away (preferably not less than 20cm), otherwise may produce noise.</p>

For the normal operation, following parts is needed:

- 1、 Input connection cable
- 2、 Output connection cable
- 3、 Ethernet cable (for Ethernet interface power amplifier)
- 4、 Cabinets or equipment mounting rack

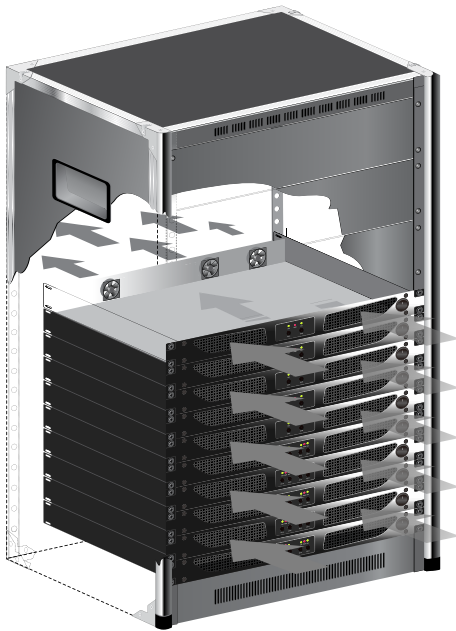

3.4 Cooling instructions

The cooling mode of the equipment is as follow: the cold air is sucked through the ventilation hole of the front panel, and the heat are taken out from the rear panel. In order to ensure good heat dissipation, please put the equipment in the 0°C~40°C environment, and ensure that the front and rear panel airway open. If the temperature exceeds 85 degrees, output voltage will be reduced, avoid excessive temperature rise. If the temperature continues rise up to 90 degrees, the power amplifier will be shunted down, when the temperature dropped to a safe temperature, the equipment will restart automatically.

After working for some time, if the cooling effect is not good, please turn off the equipment and remove the dust net cover to clean up the dust.

3.5 Power cord

	<p>The grounding end of the power cord must be grounded, otherwise there is a risk of electric shock!</p>
---	---

The power cord must have sufficient current capacity, AC power supply voltage and frequency must be in range of $\pm 10\%$ of the nominal value.

3.6 Input / output line

Common knowledge:

Try to use the shielded wire, the higher density shielding layer is the better.

Try to select balance connection for input, to reduce noise interference.

Selection of non balance connection, the shorter the better, preferably not more than 3m.

The weak signal line should avoid to parallel with the power line and the power output line, otherwise it might produce noise.

Before changing any connection, please turn off all equipments. Otherwise, it may cause damage to hearing and speakers.

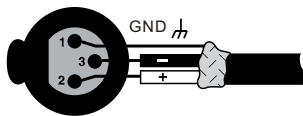

Balanced analog input and AES3 digital input connection

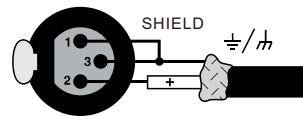

Non balanced analog input connection

3.61 Stereo Mode

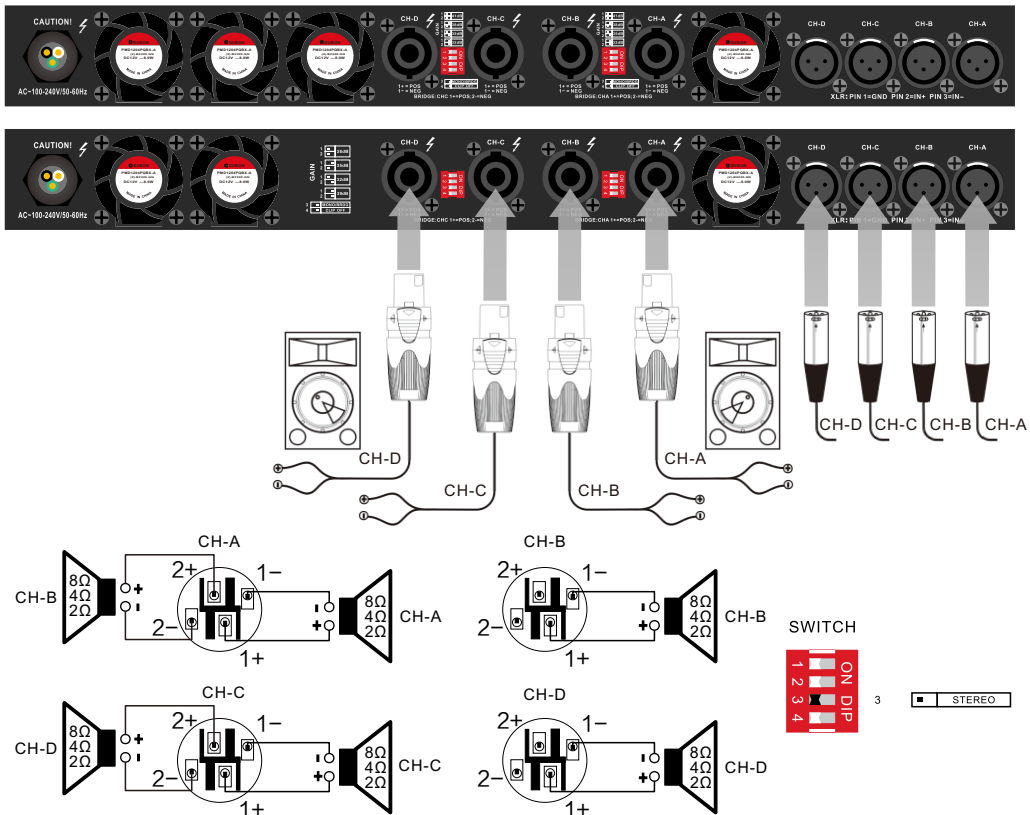

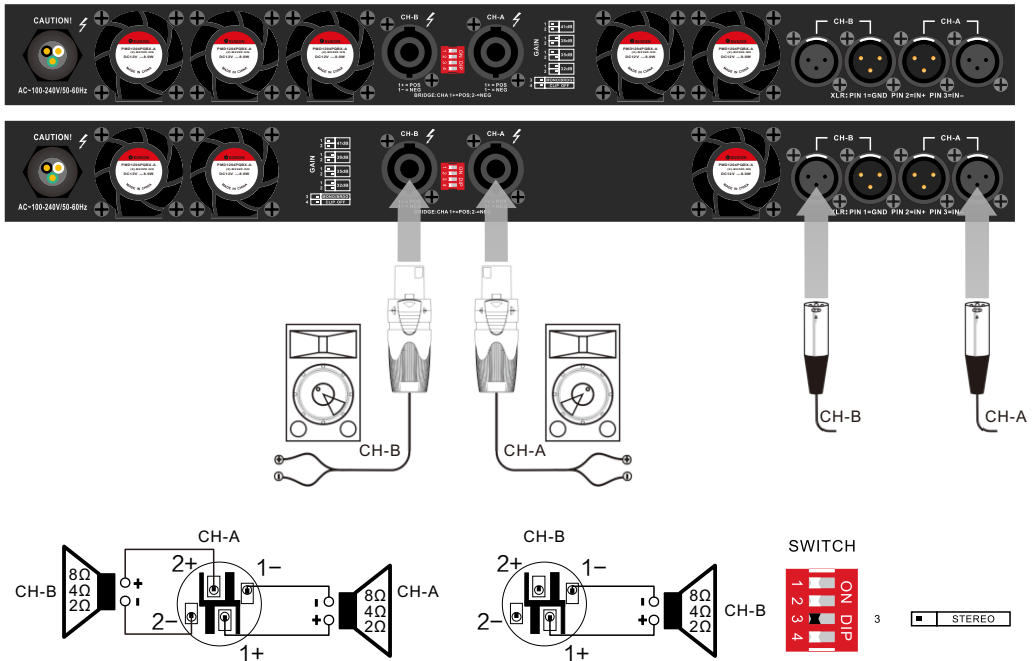

3.62 Bridge mode

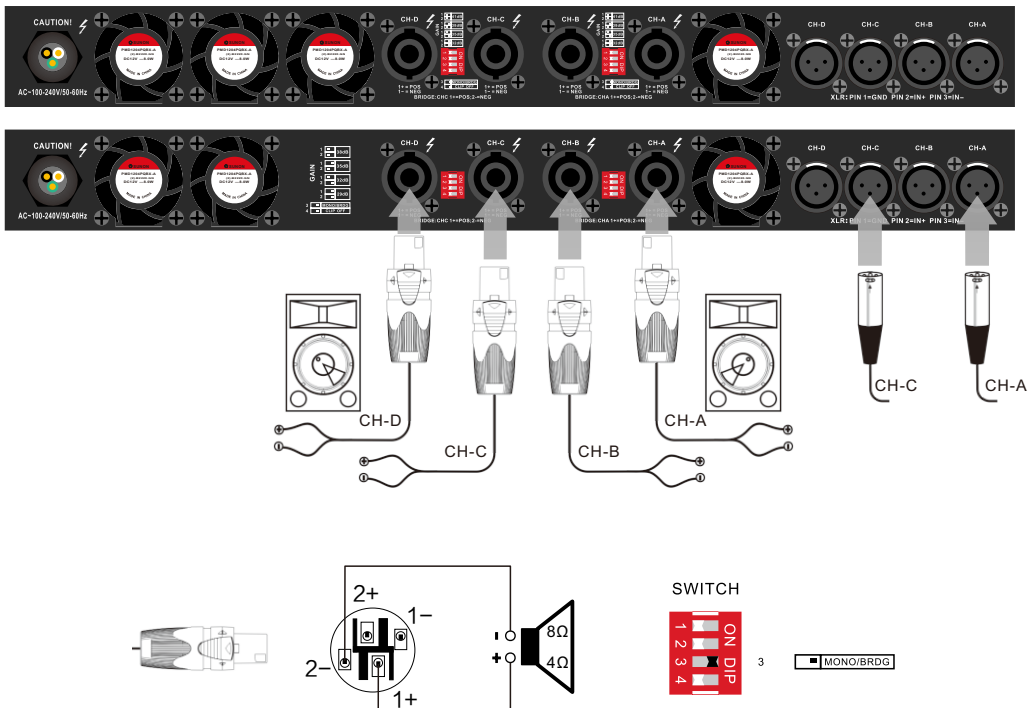

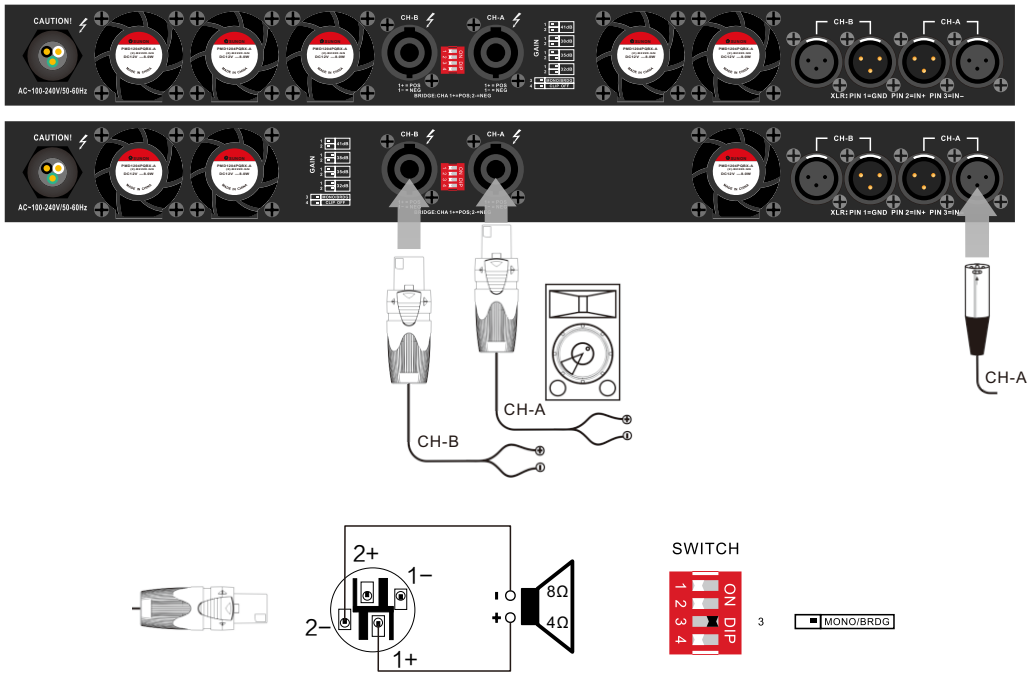

3.63 Mono mode

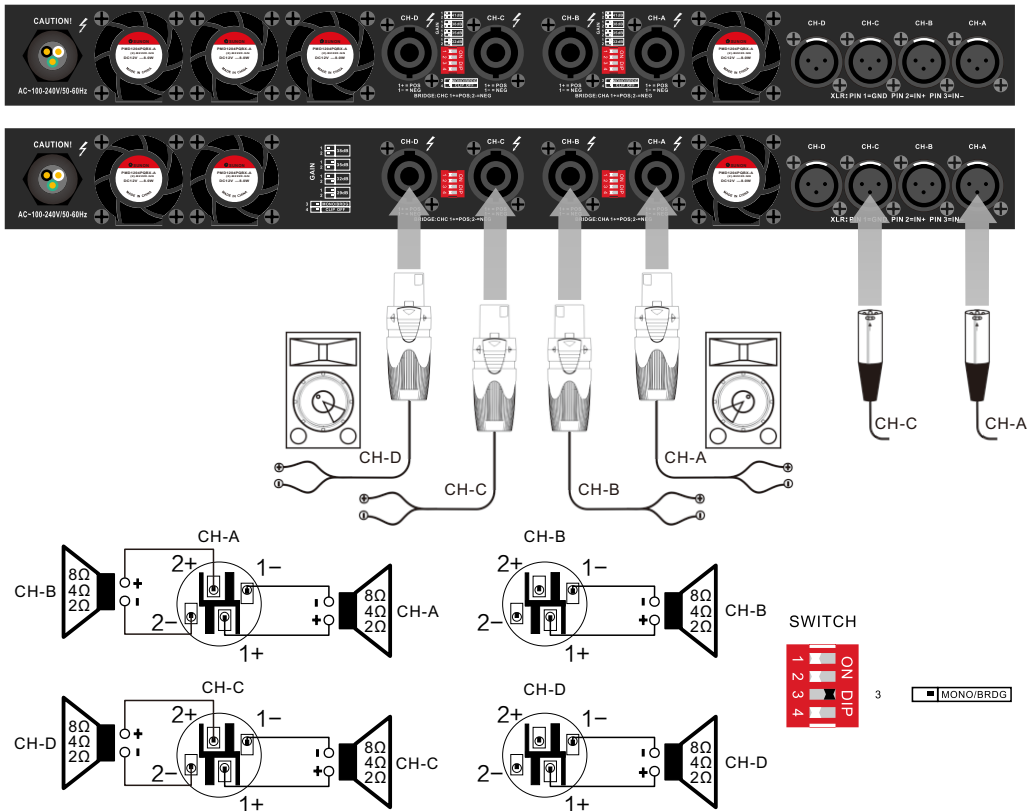

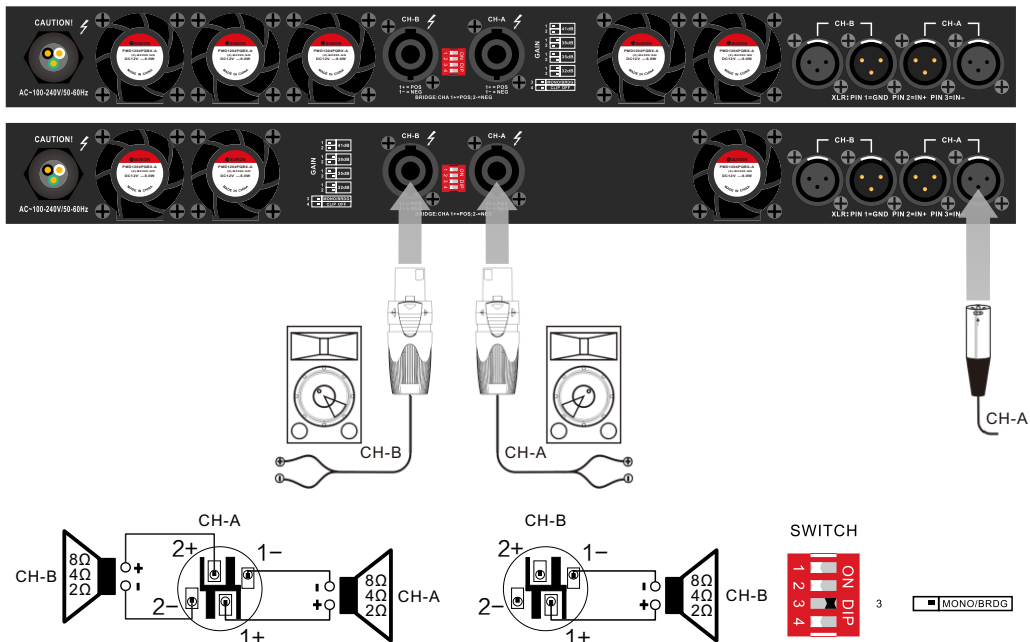

4 Operating instructions

	<p>Before installation, make sure that the power cord is not connected to the power outlet; the power switch is turn off; the volume knob is completely closed (counter clockwise to the limit).</p>
--	--

4.1 Protection speaker

Clipping not only make sound distortion, but also damage the tweeter, you can reduce the input signal to avoid clipping.

Strong sub signal will cause the speaker burned. The high level low frequency signal caused by the falling of the microphone is a typical sub acoustic signal. One of the following ways to prevent sub sonic signals should be used:

- a. Installing a high pass filter between the mixer and amplifier.
- b. Turn on the high pass filter in the mixer. Without affecting the use, the filter frequency is set as high as possible. For example, for the music signal is set to 35Hz, for the microphone set to 75Hz.

4.2 Attention

In order to achieve the best performance and the highest security, please pay attention:





- 1、 Before use, you need to configure the amplifier, including the input and output lines. Improper wiring will lead to the equipment can not work properly. For information about connection and configuration, please refer to the “installation” section of this manual.
- 2、 Be careful when connecting, selecting the input signal and controlling the output level. This can avoid unnecessary trouble.
- 3、 Do not connect the ground wire of the input and output cable together . This will form a ground loop and cause oscillations.

- 4、 Do not connect the output cable to the power supply, Otherwise it may cause electric shock.
- 5、 Without authorization, modify the circuit will be dangerous, and the agents will not provide any services.
- 6、 Do not use the amplifier in the SIG LED continuous flashing yellow.
- 7、 Do not make mixer overload, otherwise it will send clipping signals to the amplifier. Power amplifier will accurately reproduce such signals, the speaker may be damaged.
- 8、 Do not use the amplifier under the condition of lower than the nominal load. Too low load may cause amplifier output protection and premature clipping ,damage the speaker.
- 9、 When the amplifier is turned on, the output port may be fatal.





Important note: our company is not responsible for the damage caused by excessive use.



4.3 Operation panel



Icon	function	illustration
	Signal LED	As the input signal is greater than "-32dB", LED is green; As the output signal is distorted by more than 1%, or when the power is compressed, LED is yellow; As there is protection, LED is red.
	Power LED	As the power switch is turn on, LED is green; As the temperature limiter to work,, LED is yellow;
	Volume	Adjust the output amplitude of the amplifier
	Power switch	ON/OFF control. It is ON ,as "I" is pressed down.

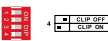

Icon	function	illustration
	Power supply input	DA 7.2,DA 8.4: 10A , 3×2.5mm ² Power cord
	Signal input	Female XLS :Balanced audio input plug
	Signal input	Male XLS :Balanced audio input plug
	Gain switch	Set to 41dB, the amplifier voltage gain is 41dB; Set to 38dB, the amplifier voltage gain is 38dB; and so on.

	<p>Mode switch</p>	<p>STEREO Each channel is independently. CHA input signal output from CHA; CHB input signal output from CHB; and so on. MONO/BRDG CHA input signal output from CHA and CHB; CHC input signal output from CHC and CHD.</p>
	<p>CLIP Switch</p>	<p>Set to ON, the clipping limiter is on; Set to OFF, the clipping limiter is off.</p>
	<p>Speakon</p>	<p>Four core SPEAKON speaker socket: When the amplifier is in the Stereo mode, CHA\CHB will connect through this socket, the method is below: 1+, 1-.</p>

5 Gain and sensitivity

The user can set the power amplifier's sensitivity through the switch on the back panel, so as to match with the third party devices. 26dB,29dB, 32dB,35dB, 38dB,41dB are selectable.

Input signal: 1kHz sine wave, Amplitude value is RMS.

增益(dB)	DA 7.2	DA 8.4
29	—	3.17V
32	3.18V	2.25V
35	2.25V	1.59V
38	1.59V	1.13V
41	1.13V	—

6 Trouble shooting

The following table lists the main causes and treatment measures for the abnormal working, as well as the action of the protection circuit for each case.

Fault state	Causes	Treatment
PWR LED is not bright	Not connected to AC power source	Check the AC line network
	The power switch is not turned on	Turn on the power switch
PWR LED is yellow	amplifier overheating	Check whether the fans are working properly on the rear panel in the amplifier, check whether the air around the power amplifier is open.
SIG LED is yellow	Input signal is too large	Reduce input signal.
SIG LED of all channel continue to be yellow.	Total output power is overload.	Check load. The minimum load is 2 ohm for Stereo and MONO; The minimum load is 4 ohm for BRDG.
SIG LED of all channel is red.	Amplifier outputs DC.	Consult technical support center.
Output continuous clicks	Connection bad or shorted	Check connections.

7 Specification

		DA 7.2	DA 8.4
Rated Output Power(THD+N=1%, 1kHz continue sine wave, all channel driving)	8Ω/Stereo	2X2200W	4X1350W
	4Ω/Stereo	2X3500W	4X2000W
	2Ω/Stereo*	2X4200W	4X2800W
	16Ω/Bridge	1X4400W	2X2700W
	8Ω/Bridge	1X7000W	2X4000W
	4Ω/Bridge*	1X8400W	2X5600W
Output RMS voltage(THD+N=1%, 1kHz)		126.5V	89.4V
Slew rate(1kHz, low-pass filter bypassed)		50V/us	
Sensitivity(Rated Power, 1kHz)		selectable 41dB 38dB 35dB 32dB	selectable 38dB 35dB 32dB 29dB
THD+N(10% Rated Power, typical)		0.01%	
IMD-SMPTE(10% Rated Power, typical)		0.01%	
DIM30(10% Rated Power, typical)		0.01%	
Cross-talk(20Hz-1kHz, below Rated Power)		≥90dB	
Frequency response(10% Rated Power, 20Hz-20kHz, 8Ω)		±0.2dB	
Input impedance		20kΩ (Balance) , 10kΩ (Unbalance)	
Damp factor(8Ω, 20Hz-200Hz)		≥5000	
SNR(A weighted 20Hz-22kHz)		≥112dB	≥109dB
Main power		90~260VAC, 50~60Hz	
Protection		Under voltage, DC, Over temperature, Over load limiter, Short protection.	
Size(W×H×D)		483x44x370mm	
Net weight		9kg	

* Test condition: 20ms, 1kHz, THD+N=1%.

8 Power consumption and heat

Test signal: Pink Noise, bandwidth limited from 22Hz to 22kHz

1/8 power is typical of program material with occasional clipping. Refer to these figures for most applications.

1/3 power represents program material with extremely heavy clipping.

2x1000W

	LOAD	Line Current(A)		Power(W)			Thermal Dissipation	
		220V	110V	IN	OUT	Dissipated	Btu/h	kcal/h
standby		0.4	0.8	90.0	0.0	90.0	307.1	77.4
1/8 power	8Ω/CH	1.6	3.2	347.2	250.0	97.2	331.8	83.6
	4Ω/CH	2.6	5.2	574.3	425.0	149.3	509.6	128.4
1/3 power	8Ω/CH	3.7	7.5	823.0	666.7	156.4	533.7	134.5
	4Ω/CH	6.3	12.6	1382.1	1133.3	248.8	849.0	214.0

2x2000W

		Line Current(A)		Power(W)			Thermal Dissipation	
	LOAD	220V	110V	IN	OUT	Dissipated	Btu/h	kcal/h
standby		0.5	1.0	110.0	0.0	110.0	375.4	94.6
1/8 power	8Ω/CH	3.2	6.3	694.4	500.0	194.4	663.6	167.2
	4Ω/CH	5.2	10.4	1148.6	850.0	298.6	1019.2	256.8
1/3 power	8Ω/CH	7.5	15.0	1646.1	1333.3	312.8	1067.3	269.0
	4Ω/CH	12.6	25.1	2764.2	2266.7	497.6	1698.0	427.9

2x3000W

		Line Current(A)		Power(W)			Thermal Dissipation	
	LOAD	220V	110V	IN	OUT	Dissipated	Btu/h	kcal/h
standby		0.6	1.2	130.0	0.0	130.0	443.7	111.8
1/8 power	8Ω/CH	4.7	9.5	1041.7	750.0	291.7	995.4	250.8
	4Ω/CH	7.8	15.7	1723.0	1275.0	448.0	1528.8	385.3
1/3 power	8Ω/CH	11.2	22.4	2469.1	2000.0	469.1	1601.0	403.5
	4Ω/CH	18.8	37.7	4146.3	3400.0	746.3	2547.0	641.9

4x500W

		Line Current(A)		Power(W)			Thermal Dissipation	
	LOAD	220V	110V	IN	OUT	Dissipated	Btu/h	kcal/h
standby		0.6	1.3	140.0	0.0	140.0	477.8	120.4
1/8 power	8Ω/CH	1.6	3.2	347.2	250.0	97.2	331.8	83.6
	4Ω/CH	2.6	5.2	574.3	425.0	149.3	509.6	128.4
1/3 power	8Ω/CH	3.7	7.5	823.0	666.7	156.4	533.7	134.5
	4Ω/CH	6.3	12.6	1382.1	1133.3	248.8	849.0	214.0

4x1000W

		Line Current(A)		Power(W)			Thermal Dissipation	
	LOAD	220V	110V	IN	OUT	Dissipated	Btu/h	kcal/h
standby		0.7	1.5	160.0	0.0	160.0	546.0	137.6
1/8 power	8Ω/CH	3.2	6.3	694.4	500.0	194.4	663.6	167.2
	4Ω/CH	5.2	10.4	1148.6	850.0	298.6	1019.2	256.8
1/3 power	8Ω/CH	7.5	15.0	1646.1	1333.3	312.8	1067.3	269.0
	4Ω/CH	12.6	25.1	2764.2	2266.7	497.6	1698.0	427.9

4x1500W

		Line Current(A)		Power(W)			Thermal Dissipation	
	LOAD	220V	110V	IN	OUT	Dissipated	Btu/h	kcal/h
standby		0.7	1.5	160.0	0.0	160.0	546.0	137.6
1/8 power	8Ω/CH	4.7	9.5	1041.7	750.0	291.7	995.4	250.8
	4Ω/CH	7.8	15.7	1723.0	1275.0	448.0	1528.8	385.3
1/3 power	8Ω/CH	11.2	22.4	2469.1	2000.0	469.1	1601.0	403.5
	4Ω/CH	18.8	37.7	4146.3	3400.0	746.3	2547.0	641.9

*1W=0.860kcal/h, 1BTU=0.252kcal

9 Maintenance

The internal circuit of the equipment is very complicated and can only be maintained by the trained professional technicians. If a failure occurs, contact our technical support.

When the equipment is sent back to the maintenance, please fill in the "maintenance information card" and send it back with the equipment together.

Do not transport any attachments with the equipment, such as power lines, manuals, etc.. These articles are not required for maintenance, and we are not responsible for these items.

Adequate protection must be given to the equipment. We recommend the use of the original packaging materials.

10 Packing directions

- 1、 Please fill out the attached "Maintenance Information Card" in the back of the manual.
- 2、 Do not transport the unit with any accessories, such as the wires, hardware and the manual. The product's repair does not need these items, and these items we are not responsible for.
- 3、 When transporting the products, it must be fully protected. We recommend that you send back to repair with the original packaging.
- 4、 If you transport the unit with your own packaging, the simple packaging at least meets the following requirements:
 - a、 Use the double-layer carton which has passed the 275 PSI (PSI: pressure units, 1kg/cm² approximately 14.5 PSI) burst test, and leave 8cm space to fill the solid foam polystyrene at the six surfaces.
 - b、 Use enough sealing tape to seal the carton.
 - c、 Do not use thin carton. The damage due to the poor packaging will not be able to enjoy the warranty.

11 Maintenance outside the warranty

First we will detection the equipment, and tell you the maintenance fee, you need to pay, then we began to repair. If you do not agree with the maintenance, please contact the company customer service center to reclaim equipment as soon as possible. The company has no obligation to keep your equipment, if 30 days yet not to get back to your equipment, the company will have the right to dispose of.

12 Warranty

We provide three (3) years warranty from the buying date, for any reason caused failure (except Items not included in the scope of the warranty).

13 Items not included in the warranty

Warranty applies only to new products within the warranty period. This warranty does not cover following cases: damages due to improper use, accident; losses be insured by the insurance contract; serial number to be defaced, modified or erased; damages caused by improper transport packaging; unauthorized maintenance or modification of the product.

14 Warranty responsibility

For any defect, regardless of fault reason (except items not included in the scope of the warranty) we will remedy by repairing, replacing, or refund (we can not provide replacement services, and repair can not solve the problem or can not provide timely repair, otherwise we will not choose a refund). If you choose a refund, you must return the faulty products to us free of charge, and do not retain any lien or mortgage. Refunds shall be the same as the actual purchase price, excluding interest, insurance, handling and other expenses. Warranty can only be performed in authorized service center or factory. We will repair the product defects and deliver the product in a reasonable time.

15 How to obtain warranty service

You must inform us your warranty service in the warranty period. Our authorized service center takes the corresponding quality assurance measures within the reasonable time after receiving the defective products. If you are not satisfied with the result of the repair, please inform us immediately.

16 Indirect or accidental damage Disclaimer

You have no right to receive any compensation for any damage caused by any defects in our new products, include any damage caused by this type of defect to other products.

The company is not responsible for any loss incurred directly or indirectly as a result of equipment damage.

17 Warranty modification

No one has the right to expand, or modify this warranty. This warranty will not be prolonged because you did not use the equipment.

18 Design change

We reserve the right to change the design of any product at any time without notice, and do not undertake the obligation to make corresponding changes to the products previously produced.

19 Buyers legal remedy

After the expiration of the warranty, the company will have the right to stop the implementation of any quality assurance measures.

This statement will take precedence over any other statements contained in this manual.

